



11.22.17-2

## 2018 LATE MODEL DIVISION RULES

### 1. FRAMES, CHASSIS, and CAGES

- A. All cars will have minimum 104.5" and maximum 105.5" wheelbase, measured from center of lower ball joint to center of rear end, with a maximum tread width of 64.5".
- Tread width to be measured with ACT tread width gauge
  - Tubular frames on all models main frame rail members shall have a minimum of:

**10" perimeter tubing - .120 wall thickness – measured 2x3x2x3**

**12" perimeter tubing - .095 wall thickness – measured 3x3x3x3**

**16" perimeter tubing - .083 wall thickness – measured 4x4x4x4**

#### **NO NOTCHING or CUT OUTS ALLOWED for suspension travel**

- Sections extending, such as front and rear clips, must be a minimum of 10 inches in perimeter and have a minimum of .083" wall thickness and extend 10 inches minimum beyond wheelbase.
- Rear clip must extend beyond fuel cell area.
- V-8 engines only and must be placed with center of number one spark plug or center of hex if angle fitted even with center of grease fittings on upper ball joints.
- Ford engine will be measured from front of right head to center of right front ball joint. (This will result in 1-7/8ths inch setback compared to Chevrolet.)
- **Centerline of engine must remain within 1/2" (1/2 inch) measurement of centerline of tread width, measured from the inner pivot point of equal length front lower control arms on both sides of snout. A-frame suspensions will be measured from lower ball joints.**
- ACT perimeter chassis, by definition, must maintain equal lower control arm measurements.
- Material to be used must be DOM or seamless, .090 minimum wall steel tubing.
- Maintain integrity of tubing and wall thickness throughout the construction of Frames, Chassis, and Cage.
- All cars required to have a 4-point or main structure of the roll cage and must be symmetrical in all directions, (See roll cage section 5 below).
- Minimum 1-1/2" diameter tubing inside driver's compartment.
- Four curved horizontal door bars on driver's side.
- Minimum height of door bars 22-1/2 inches from bottom of frame.
- Passenger side three curved door bars with minimum 66 inches between driver's side door bars and passenger side door bars, outside to outside, or an "X" bar with approved side body panel supports.
- A so-called "Petty Bar" must run from center of cage to upper right front halo.
  - > **Main frame rails and clips may not be pierced or drilled or otherwise altered for purpose of reducing weight.**
  - > **All lead must be painted white, with car # painted in contrasting color.**
  - > **Bolts must pass through lead, and must be secured with proper sized bolt and nut. No pinch bolts allowed.**

#### B. Specifications for Perimeter Chassis and Roll Cage

1. **NO OFFSET CHASSIS ALLOWED, UNLESS SPECIFIED IN RULES.**
2. **Center Section Frame Rails:** Measured from inside to inside at MINIMUM 52 inches with 1/4 inch tolerance.



Grandfather Rule: Pre-January 31, 2012 for REGISTERED CARS WITH ACT:  
Center section frame rails that measure width **less than 51.75"** and more than 51" will be

required to bolt two 5 lb. pieces of lead, one piece within two inches from the front and one piece within two inches from the rear of the 47 inch right frame rail. Lead will be painted white and mounted on outside of rail for easy removal for inspection purpose.

Center section frame rails that measure width **less than 51.0"** and more than 50.0" will be required to bolt two 8 lb. pieces of lead, once piece within two inches from the front and one piece within two inches from the rear of the 47 inch right frame rail. Lead will be painted white and mounted on outside of rail for easy removal for inspection purpose.

Center section frame rails that measure width **less than 50.0"** from inside to inside should contact the ACT office.

**3. Right Frame Rail:** Must be minimum 47 inches in length.

➔ Grandfather Rule: Pre-January 31, 2012 for REGISTERED CARS WITH ACT:  
Right frame rails that measure less than 47" will be required to bolt on a piece of lead equal to 1 lb. per inch violation to a maximum of three inches. Lead must be painted white and mounted on outside rear of rail for easy removal for inspection purpose.

**4. Offset**

- Maximum **offset** allowed 1" from center line measured ½ inch from center line equally side to side with total maximum 1 inch offset. Center line determined by using the center section measurement (2) above.
- An ABSOLUTE offset tolerance of ¼ inch will be allowed.

➔ Grandfather Rule: Pre-January 31, 2012 for REGISTERED CARS WITH ACT:  
A violation of the 1" offset allowance for cars built before January 31, 2012 will be at a ¼ inch tolerance. For every additional ¼ " of offset or fraction thereof, a weight penalty of **24 lbs. per inch**, or comparable ¼ fraction of inch will be required (i.e. 6 lbs. per ¼").

**5. Roll cage/Halo**

- Rollcage structure will be made of 1 ¾ O.D. inch tubing with .090 minimum wall steel tubing.
- Additional components within center rollcage section must be minimum 1 ½ inch diameter tubing and minimum .065 wall steel tubing.
- Integrity of roll cage must be maintained.
- Height of roll cage total symmetry to be no less than 40".
- Total height of Halo to be no less than one inch lower than cage.
- Width of Halo measurement minimum 44 inches measured from outside to outside of tubing.
- Rear roll cage posts must be attached to frame rails in a direct diagonal straight line from fire wall (see rulebook diagram for further clarification).

➔ Grandfather Rule: Pre-January 31, 2012 for REGISTERED CARS WITH ACT:

1. A roll cage height tolerance of ½ inch will be given with no penalty
2. Width of Halo will receive 2" tolerance
3. Halos that measure less than 44 inches wide but more than 43 inches wide will be required to weld or securely fasten a one-pound piece of weight to the middle of the right halo bar
4. Halos that measure less than 43 inches wide but more than 42 inches wide will be required to weld or securely fasten a two-pound piece of weight to the middle of the right halo bar
5. Halos that measure less than 42 inches wide but more than 41 inches wide will be required to weld or securely fasten a three-pound piece of weight to the middle of the right halo bar

6. Halos that measure less than 41 inches wide but more than 40 inches wide will be required to weld or securely fasten a four-pound piece of weight to the middle of the right halo bar

6. **Rear clip must be centered to center section of frame rails. NO offset allowed. Fuel cell must be centered between rear frame rails.**

C. 18 gauge steel minimum, 18 inches high foot firewall. **Top of foot box must be 18 gauge steel.** 9-inch high driver's tunnel and 18 inch high behind seat.

A "Red Mead" bar or 1/8" minimum steel plate is mandatory under driver's seat (see diagram below). A foot safety bar is mandatory. A support for headrest or seat back extending to support back of head is mandatory.

## 2. INTERIOR DETAIL

A. A full width dash is required in all cars. Vertical surface of dash must project in a single plane across the car. Top horizontal plane of the dash should carry forward to the firewall and enclose entire area beneath windshield. Instruments must be neatly mounted to vertical plane of dash panel.

B. Interior of car must be completely enclosed with respect to engine compartment, track surface, tires and rear fuel cell compartment. Interior panels must be minimum of .040 inch thickness of aluminum or steel.

C. Only one rear view mirror inside car approved. A left side exterior mirror is approved, but cannot extend outside of the windshield "A" pillar.

D. No rub rails allowed outside car.

E. *A maximum 6" deck/shelf allowed on right side of interior to door top. (See diagram)*

## 3. ELIGIBLE BODIES - See diagram – Page 17 for measurements

A. Bodies

- Bodies must be aftermarket made of plastic or aluminum with rubber front and rear bumpers, fiberglass hoods and window frames.
- ACT approved bodies only. **NO CARBON FIBER BODYPANELS.**
- Bodies must meet tech visual approval – weight penalties may be imposed at tech director's discretion for violations. No mixing and matching of manufacturer body panels.
- NO high performance bodies are approved for competition.

B. ABC bodies are required. Fiberglass quarter panels will be allowed. "Rubber" quarter panels may be used upon availability. All ABC bodies must meet manufacturer's "Referee" technical inspection, and be mounted as "out of box". **1/2" tolerance of any measurement with templates will be allowed, if consistent with majority of field of cars.**

C. Models as follows

Dodge Charger	Pontiac Grand Prix
Ford Fusion	Ford Taurus
Chevrolet Impala SS	Chevrolet Monte Carlo
Toyota Camry	

*All Ford engine cars must run an approved Ford Body. Local (weekly) competitors should conform to local rules regarding body rules; however, non-Ford Engine cars with Ford Bodies must be approved by ACT to participate in ACT-sanctioned events.*

**Any variations need tech approval and may carry penalties.**

D. Fenders

- Five Star/**AR** Narrow fenders only will be allowed :
  - 660 - 23PL
  - 660 - 23PR
  - 663 - 230
  - 1000 - PX
  - 10000X
- Plastic roof panels are optional.
- **There will be NO “wide fenders” allowed, regardless of the manufacturer.**

E. **All body panels must be complete in length and width.** Overall workmanship shall be a determining factor as to whether a car shall be approved for competition. Specified components' compliance to templates and overall level of workmanship and appearance will be considered by technical inspectors. **See diagrams – Page 17 for body measurements.**

F. **No bumper tubing or bracing allowed lower than front or rear bumper covers.**

G. **ABC body measurements must be strictly adhered to – templates will be *used* to measure from front windshield to rear spoiler, and from right quarter panel to left quarter panel, with ½” tolerance, when determined by ACT officials.**

4. **SPOILERS**

A. ALL REAR SPOILERS MUST BE MADE OF LEXAN AND MUST REMAIN CLEAR, maximum width of 60 inches wide and 5 inches high. All heights reference to ABC body dimensions. No side enclosure, no lips or bends in upper portion of spoiler and must be flush to vertical surfaces of deck lid, **and must be mounted center of rear bumper cover.**

B. ABC spoiler heights will be according to instruction manual and will be subject to approved inspections. Measurement will be from top flat surface at the end of trunk lid to ground at 34-7/8”. See spoiler section above for approved spoiler size, (60 inches wide and 5 inches high).

5. **HOODS and TRUNKS**

A. Hoods must be hinged. Hoods must have four positive locking pins on leading edge. Trunks must have two positive locking pins.

6. **EXHAUST/HEADERS**

A. Exhaust

- Absolutely no additional holes, vents, etc., may be added to body components outside stock configuration.
- Exhaust holes may be cut.
- Recommended that exhaust exit under car, or may exit out side of car. If exhaust exits under car, must point toward race track and maintain 4” ground clearance.
- **Exhaust must exit in duals.**
- Two **unaltered** mufflers required.
- Mufflers must be Howe #3002 and steel pipe used to extend beyond driver seat, and may not be cut or modified and **MUST BE** installed in correct flow direction **and used in its entirety.**
- Exhaust pipe exit maximum size 3-1/2 inches.
- No scavenger systems.
- MAGNAFLOW Muffler Part #11219 may be used.
- Either weekly or touring competitors must be in compliance with track and/or local ordinance rules.

B. Headers allowed. No 180-degree headers allowed. All 4 tubes from right and left banks of engine must enter single collector on each respective side of exhaust. No balance tubes or any crossover type exhaust systems allowed. Must be made of mild steel, no stainless. **Must exit in duals.**

## 7. WINDOWS

A. A full stock dimension windshield is mandatory and must be constructed of 1/8<sup>th</sup> inch minimum thickness lexan. Three internal windshield braces spaced at least on 5 inch centers and roughly centered upon windshield constructed of minimum 1 inch wide by 1/8 inch thick material are mandatory.

B. Models with rear quarter windows may have stock openings covered with securely mounted solid, clear lexan. Rear side window may have approved air vents for driver. "A" pillar windows not to exceed **12"** in any direction measured from front of door opening. No interior air deflectors allowed.

C. A full dimension rear glass constructed of minimum 1/8<sup>th</sup> inch thick **clear** lexan is mandatory and must be held securely in place. **Back window must be securely braced internally to prevent significant bowing or distortion at racing speed.**

## 8. NUMBERS

A. A quality paint job is mandatory on all cars with **high contrast** numbers for legibility day or night. Bodies must be kept neat and painted at all times. No metallic numbers.

B. A minimum 24-inch high, 3-inch stroke number is required on the door area on both sides of car. A minimum of 30-inch high, 3-inch stroke number is required on top of roof facing the passenger side of car. **A block style number is REQUIRED on right (passenger side) front windshied..** All numbers must be ACT registered and/or assigned. Number alterations may be required at any time by ACT to avoid duplication.

**C. All registered and /or assigned numbers MUST also have their registered state on both doors and roof of car.**

## 9. CHASSIS/BODY HEIGHTS

A. Minimum ground clearance of any component is **"4 inches"**, including bumper, bumper covers, and side skirts. If a valence is used, it must have all bolt holes filled with secure fittings and may not be movable.

## 10. WEIGHTS

A. Weight: **2800 lbs. (All ACT legal cars)**  
(Weights subject to change in the interest of parity)

- All cars will be weighed with drivers (no substitutes).
- **Cars must have a maximum 57.0% of total weight on left side.**
- All heights will be measured with driver in car, including after heats and features unless otherwise notified.

B. Cars must weigh approved weights after all qualifying heats. Cars must weigh **minimum 2800 lbs.** at start of all qualifying and feature events. **After qualifying, all weights must be minimum 2800 lbs.**

C. The following allowances will apply in post race tech inspections:

<b>Scheduled:</b>	<b>50 lap event:</b>	<b>35 lbs. tolerance</b>
	<b>100 lap event:</b>	<b>75 lbs. tolerance</b>
	<b>101–200 lap event:</b>	<b>100 lbs. tolerance if fuel stop is required</b>

**Post race fuel weights may be adjusted if necessary with notification at driver's meeting.**

D. Ballast weight must be securely attached to main frame rail or major cross member structure. Ballast is not allowed to be placed in front of or behind front or rear tires. No tungsten, lead shot, ball bearing type, or liquid type ballast permitted. No moving weight allowed. Additional brackets or weight holders beyond main frame rails must be approved by technical committee and may require modification or elimination upon inspection. Any questions can be addressed at practice sessions prior to season opening events.

## 11. ENGINES

NOTE: RPM RACING ENGINES LLC IS THE MOTOR BUILDER OF RECORD FOR ACT.

**THE FOLLOWING ARE RPM RACING ENGINES LLC APPROVED SATELLITE ENGINE BUILDERS:**

**RPM RACING ENGINES LLC**  
802-524-7406

**LARRY'S AUTO MACHINE**  
860-449-9112

**NAT'S RACING ENGINES**  
508-336-4142

**REDLINE PERFORMANCE ENGINES**  
207-418-1695

**BUTLER-MACMASTER**  
207-623-8895

**RL RACING ENGINES**  
450-464-0709

**PRO-MOTEUR**  
450-759-5362

**MOTOR BUILDERS MUST USE RPM RACING ENGINES LLC APPROVED MOTORS, PROCEDURES, AND SEALS.**

- A. Certain individual track rules (including motors) may be subject to ACT inspection, procedures, weight penalties, restrictor plates, and any other modifications ACT deems necessary in the interest of competition.
- B. #GM 88958603 or **19318604 ACT sealed motor only.**
- C. **ALL MOTORS MUST BE REGISTERED EACH YEAR WITH ACT OFFICE.**
- D. Roller rocker arms are approved. ONLY GM part number **19210724** OR GM set number **19210728** PR Scorpion part number 1035BL are approved. These are 1.5 ratio rocker arms.
- E. Contact **RPM** with any minor problems (example: pan leak, etc.) for coordinated remedy.
- F. **FORD MOTOR:**
  - 1. ACT approved **M-6007-S347JR** Ford motor only. **Must meet all specs as determined by RPM Racing Engines LLC – Contact 802-524-7406**
  - 2. Ford motor must compensate for set back by having 20 lbs. of lead bolted directly behind upper control arm section of frame rail – 10lb. each right side and left side (see diagram). Must be bolted on top, clearly visible. Lead must be painted white with car number and readily available to be moved for weighing purposes. Lead may not be moved from assigned position without consent of ACT official. [See diagram at rear of rules].
  - 3. Ford motors must have 1.600" RESTRICTOR PLATE at all ACT events held on tracks f ½ mile or over. Plates will be supplied by ACT Tech on day of race, **AND MUST BE RETURNED TO ACT DAY OF EVENT.**
  - 4. Only Ford spec motors which are ACT approved will be allowed to compete in ACT-sanctioned events.
  - 5. **Rear starters are allowed on Ford engines ONLY.**

## 12. IGNITION

- A. 6200 RPM MAXIMUM recommended for Chevrolet engines, **but will be restricted to a maximum 6300 chip, and may be required at certain tracks. Fords will be required to run a maximum 6200 chip at all events. The chip rule may be amended for certain tracks, and teams will be notified in the entry form. The chip rule may be amended in the interest of competition at any time.**

B. **MSD distributor IS allowed. Must contain light blue springs and blue advance stop. Spring and stop part number 8464, distributor numbers MSD 85551, 8570, 85561 or GM part # 10093387 are only approved parts.** No tampering or changing of advancement weights or springs allowed in HEI spec motor distributor, **2018 will be the last season HEI will be allowed.**

- MSD 6420/6425 with 6200 RPM rev limited chip optional.
- MSD must use external coil.
- Ends must be original factory MSD or weather pack connectors installed by MSD.
- It is the responsibility of the competitor to configure harnesses to allow the ACT MSD to connect.
- **MSD must be located on the right side of dash panel as far from driver as possible, and out of reach.**
- All wires must be wrapped in a loom material, and must pass through firewall at first option. Rivets to hold bottom panel must be drilled out.
- **Only one MSD box allowed. Any altering of MSD box will result in disqualification and possible suspension.**

### 13. SPACERS

- Following **carburetor** spacers are allowed:  
Canton #85060  
Moroso #64964 (aluminum)  
**HVH #SS4412-2AL is approved for CHEVROLET engine only.**
- **Any teams using the "604" MUST use "RPM 1445" Restrictor/Spacer.**

### 14. HEIGHTS

- Four (4) inch frame height measured at the lowest point including cross members.
- 47-inch roof height measured 10 inches back from windshield to ground or ABC body must meet Referee standard.
- 11-inch engine height measured from center of crank front to ground.
- Skid plate is mandatory if oil pan is below cross member.
- **Fuel cells must be a minimum height of 8 inches from ground and must be mounted center of rear frame rails.**

NOTE: (All heights measured with driver (no substitutes) in car **and all measurements are official with ACT gauges ONLY.**)

### 15. CARBURETOR, FUEL and FUEL SYSTEMS

A. A stock 4412 Holley 500 CFM carburetor only is allowed. Absolutely no material may be added or removed from carb, except bolt-on choke mechanism only may be removed. Air filter housing and fresh air box only. **Fuel must not mix with water or any additives.**

B. **"ACT US Tour and Thunder Road competitors must run approved VP C9 (unleaded) or VP 110 leaded fuel. Fuel must not mix with water or any additives, and must be approved by track officials. IT IS THE RESPONSIBILITY OF ALL TEAMS TO HAVE VP RACING FUEL IF RACING FOR 100% STATUS (i.e. point fund participation, etc.).**

*Weekly racers who participate in ACT events may run Sunoco fuel, if they choose.*

***ALL FUEL MAY BE TESTED FOR COMPLIANCE.***

C. Fuel cells mandatory and must be approved by technical inspector. Minimum 15-gallon **capacity** and maximum 22-gallon fuel cell only. It is mandatory that the fuel cell be enclosed in a 20 gauge welded steel box, with a bolt-on cover constructed of twenty gauge steel and must be protected in back and on sides by .095 1-3/4" O.D. tubing. Fuel cell will be no less than 14 inches from centerline of rear axles to front of fuel cell.

- D. Any fuel line passing through interior must be inside of steel tubing.
- E. Check valve vent is required on all fuel cells.
- F. No “**QUICK FILL**” fuel mounting allowed. Outside fuel fill **optional** with cam type fuel cap.
- G. Fuel pump must be mechanical – no electric fuel pumps. No fuel pressure regulators allowed.
- H. A“Oberg SV-0828” Fuel line safety check valve anti-siphon or a manual shut off accessible from outside of car is mandatory.**

**16. STEERING**

- A. Any type of front steering allowed. Steering box or rack and pinion are allowed.

Power steering pumps must be driven from the front of motor by belts. Steering columns must have minimum of two U-joints.

**17. SUSPENSION**

**NO TITANIUM PARTS OF ANY KIND ARE ALLOWED IN ACT RACING.**

- A. Any spindle made of steel. Removable steering arms must be made of steel. Spindles must be same offset left to right.

- B. Any stock or aftermarket upper and lower control arms allowed. Lower control arms must be same length left and right. Heim joints are allowed. Measurement will be from center of mounting point to center of ball joint **housing**. Jacking bolts allowed on non-coil over cars only. Only one shock per wheel. **Only one spring per wheel. NO double springs allowed.** No devices to limit or stop suspension travel allowed.

- C. All springs must be made of steel—magnet must stick to spring. Coil-overs permitted. **If running coil- over all parts must be same left to right and front to rear.** Spring rubbers will be allowed, must be wired in place. **Maximum of 3 spring rubbers in any spring, and must be approved in size and shape by ACT. Aluminum, steel or additives are not allowed in spring rubbers. Maximum length of spring rubber allowed is 3.5” on 3” rubber or 4.5” on 5” rubber.**

**NOTE: SPRINGS THAT COST EXCESSIVE AMOUNTS OF MONEY WILL NOT BE ALLOWED IN ACT RACING. VIOLATIONS WILL BE DEALT WITH ON AN INDIVIDUAL BASIS.**

1. MAXIMUM COST OF SPRING MAY NOT EXCEED \$200.00 EACH, AS DETERMINED AND DICTATED BY ACT. **Any team found in violation of the maximum \$200 cost rule as determined by ACT will be disqualified from event, suspended for minimum of two events, and other additional penalties may be imposed.**

2. DRACO AND RENTON SPRINGS, COSTING MORE THAN \$200.00, OR ANY SUBSEQUENT SPRING THAT ACT FINDS COST PROHIBITIVE, ACCORDING TO ACT PRICE INTERPRETATION, WILL NOT BE ALLOWED IN ACT LATE MODEL RACING.

- D. **NO SUSPENSION TRAVEL LIMITING DEVICES ALLOWED UNLESS SPECIFICALLY OUTLINED IN THE ACT RULEBOOK.** (Examples include, but are not limited to: bump stops, coil binding, chains, or shock mounting locations).

(Cars will be inspected using one and one half inch (1½”) ramps and nose of body must hit ground when pushed **down and held down** by three crewmembers or will be considered illegal). *Bumper must be mounted SOLID. No hinges or slides – must comply with nose height rule at all times.*

The intent of this rule does just one thing...it eliminates “**bumping**” the cars that compete in ACT-sanctioned events.



**VISUAL INSPECTION BY OFFICIALS TO MEET THE “NO BUMPING ALLOWED” RULE WILL BE UP TO CHIEF TECH INSPECTOR AND CONSIDERED FINAL.**

- E. No jacking bolts or any other shock travel adjusters allowed (exception: see #18 B above).
- F. **Shock Adjusters** of any kind will not be allowed. NO preloaders of any type allowed.
- G. **NO Coil-over Eliminators** of any kind allowed on ACT Late Model approved cars

**18. SHOCKS**

Brand approved is KONI and must be run at all ACT events.

Model #:

KON30-7436

**KON30-7499**

KON30-7325

KON30-9325

KON30-9436

KON30-7647

1. **No KONI approved 9” shocks will be allowed on the front of cars. Approved KONI shocks are mandatory 7” on the front and 9” on the rear ONLY.**
  2. **A 7” shock at approved race ride height will maintain a maximum compression of within 3.0 inches (there will be a reasonable variance not to exceed .5 inches at the sole discretion of the technical inspector).**
  3. **A 9” shock at approved race ride height will maintain a maximum of 4.0 inches (there will be a reasonable variance not to exceed .5 inches which will be at the sole discretion of the technical inspector). Rear shocks must maintain a minimum of 3½” travel.**
- Shock bump stops enclosed with KONI package will **NOT** be allowed on ACT approved KONI shocks.
  - ONLY PART NUMBERS LISTED ARE APPROVED FOR ACT LATE MODEL COMPETITION.
  - NO CHANGING OR ALTERING SHOCK IN ANY WAY.
  - SHOCKS MUST NOT BE PAINTED, AND MODEL NUMBERS MUST BE FULLY LEGIBLE.
  - Shocks may be swapped at any time with ACT inventory by ACT Tech Inspectors.

**19. SWAY BAR**

- A. Aftermarket one solid bar side to side only. MUST be mounted on bottom side of front clip & work off the lower A-frames. NO rear sway bars allowed.
- B. Sway bars must be mounted parallel with front cross member and will be measured from rear of engine with **1” tolerance** **Maximum sway bar diameter 1.75”**

**20. BRAKES and HUBS**

- A. Any safety or racing type hubs allowed made of **steel, aluminum, or magnesium and of same offset right and left.** 5x5 or wide 5 bolt patterns allowed. Front brake rotors must be a minimum of 1 inch thick and made of steel. Rear brake rotors must be minimum ¾ inch and made of steel.

B. Brakes (all four) must be single piston calipers made of steel and all four must be in good working order. Master cylinders and pedals of any type allowed. **No brake coolers allowed.** Brake ducting allowed with no blowers.

C. Vents may be installed for front brakes only.

## 21. REAR ENDS

A.

1. Rear ends must have floating type bearing and hub such as quick change or “non-quick” change, front load quick change, or steel housing-type 9” floater with steel center section gear carriers only allowed.

2. No cambered rear ends or rear ends with yaw (dog tracking), or offset or shimmed snouts allowed.

3. No crowned axles.

4. All rear ends must be driven with solid drive flange plates.

5. NO TITANIUM PARTS ALLOWED.

6. All running gear drainage plugs must be safety wired.

7. No rear axle tube tow in or out allowed.

B.

- Rear ends **must have spool ONLY**. At select events, a rear end gear rule will be in effect and posted in entry forms.
- No gold tracks or any type of ratchet or limited slip.
- Drive shafts must be made of steel, and must be painted white.

C.

- Truck arm or three-point type rear mounting allowed.
- Rear trailing arms may use rubber bushings and heim joints.
- No spring rods.
- Rubber snubber allowed on rear trailing links.
- **One** upper link pivot with rubber bushings allowed.

D. Solid tubular pannard bar only. One bar, two adjustable heim joints only.

E. No aluminum truck arms, no fifth coils, no Watts linkage, no torque arms, no mechanical devices to transfer weight while car is in motion allowed.

## 22. COOLING SYSTEMS

1. Any radiator allowed overflow must blow on right lower quarter of windshield.
2. ACT-approved spec motors may run electric fans.
3. Stock cast water pump or aluminum pumps allowed. Oil coolers allowed.

## 23. TRANSMISSIONS/CLUTCHES

A.

1. Transmissions must be stock **GM** standard 3-speed.

- The early Muncie and later Saginaw three-speed stock transmission are the only GM transmissions approved for competition, with the following exceptions:

- a.) Saginaw three-speed may modify gear ratio with an approved dealer-made cluster gear with 1.35 ratio.
- b.) REM polishing allowed.
- c.) No rollarized gear on main shaft allowed.
- d.) No other altering of transmissions will be allowed without written approval by ACT.

2. No automatics allowed.
  3. Steel type bell housing mandatory for conventional clutch use.
  4. No carbon fiber materials will be allowed in clutch assembly.
  5. Mandatory bell housing must remain 360° and shall not be altered, except for inspection hole not to exceed 2" in diameter to be drilled in bottom of bell housing.
  6. Aluminum bell housing will be allowed with disc clutch and ACT crate motor.
  7. Shifter may be any type – single or two rod.
- B. Disc clutch assembly that will be the ACT Late Model approved clutch:  
**Quarter Master 298103 – 7.25 2 disc-V-drive**  
**GM flex plate: 14088765 ONLY**

#### 24. STARTERS

- A. Reverse mount starters allowed **only on Ford engines**. Starters must remain in stock location.

#### 25. TIRES and WHEELS

A. ACT approved 8 inch American Racer tire only. ACT tire rule is in effect for all ACT events. ACT Late Model competitors are **required** to register tires for each event. Tire registration form must be submitted to ACT designated tire coordinator a minimum of 30 minutes prior to post time. All competitors are encouraged to review the ACT tire policy addendum available in tech trailer.

B. Specified tire mandatory on all four wheels. Tires are available at track. Tires must be on an 8" rim mandatory. Front wheels must maintain same offset left and right 64.5" tread width. Rear wheels must maintain same offset left and right 64.5" tread width. Must be aftermarket racing type wheels made of steel. Wheel spacers may be used, and **must be one-piece wheel spacer MANDATORY – on wide 5 hubs. Maximum one ½" thick spacer per wheel.** Lightening of wheels of any kind not allowed – must be stock out of box.

C. Chemical treating of tires **will not be** allowed. No shaving of any tires allowed in ACT Late Model division.

D. Tire clean up with scraper blades allowed. No steel brushing or any form of liquid allowed to clean tires.

E. Questionable tires, or tires not meeting above criteria as determined by officials, may be confiscated by officials and could result in disqualification, and/or other penalties.

F. LM Tour events require use of specified tire **ONLY**.

G. **Bleeders are not recommended by American Racer.**

#### 26. Safety Requirements

A. Fire retardant driver's suit highly recommended. Fire retardant gloves highly recommended.

B. All cars must have safety cutoff switch on driver's right side crossbar. Must be within reach of driver and accessible to safety crews from both left and right side.

C. Aluminum racing seat mandatory **or carbon fiber seat allowed with SFI safety rating of 45.1.** Driver's seat must appear as close to stock position as possible and must be securely fastened (bolted, not tack welded), to rollcage and frame members and not to floorboards.

D. Quick release aviation-type minimum 3" safety belts required. Shoulder harness required to be fastened to rollcage, not in gussets. **Cam-lock type allowed. Shoulder harnesses must be NO less than 2" wide "IF" passing over head and neck restraint system.**

E. An approved driver's window screen mandatory. Requires seat belt type latch. Must be attached at top and bottom front by single seat belt locking device and 3/8" steel rod top and bottom, **or spring lock type allowed.**

- F. Rollbars must be padded in driver's area. Center of steering wheel must be padded.
- G. It is mandatory that a 2-1/2 lb. fire extinguisher with gauge be attached to the car interior, on driver's right side crossbar. Must be within reach of the driver and accessible to safety crews from both left and right side. Extinguisher must be mounted in quick release bracket only, no taping. On board fire system highly recommended.
- H. Two drive shaft loops to fully enclose drive shafts mandatory, no less than 1" wide and 1/8" thick must be placed around drive shaft front and rear attached to the floor or cross member.
- I. The following are suggested to aid in your safety: goggles, fire retardant socks and undergarments, DOT or SNELL approved automobile racing helmets.

## 27. MISCELLANEOUS

- A. Contact ACT office for licensing information as numbers will be issued to license holders only and will be assigned upon receipt of license application by the ACT office. All ACT competitors will carry state or provincial identity, which will be assigned through the ACT licensing process. No metallic numbers. Numbers remain in effect only for season issued. **Numbers on roof shall be readable from front stretch tower position.**
- B. All illegal parts must be surrendered at time of inspection to ACT official or automatic two week suspension and/or minimum \$50.00 fine. This includes questionable tires.
- C. Race procedures, inspections, and safety regulations will be governed by officials of ACT in the best interest of the sport. Officials of ACT retain the right to revise the above rules as they deem necessary. These rules and procedures will be adhered to EIRI.
- D. Radios will be allowed for the Late Model division. **One spotter per car is required in designated area for feature event.**
- E. Spotters required to have car # visible on both right and left headset ear cuff, and back of headset.
- F. No traction control devices will be allowed.
- G. **Competitors wishing to participate in purse payouts and/or point fund must run decals as required by ACT.**
- H. **Owners point fund payments will be paid on 100% participation by owner.**
- I. **Championship titles will be determined by drivers assigned points.**

## 28. ELIGIBILITY

- A. Drivers must purchase Late Model driver license and must present proof of issuance of license. Only licensed members may be allowed in pits at reduced fee..
- B. Rookie Eligibility:
  1. Driver must file Rookie Registration information with ACT Office.
  2. A driver's rookie season is defined as the first season when they qualify for more than three feature events in a single season.
- C. **Driver must attend a minimum of 80% of point-counting events to be recognized as Rookie of the Year candidate.**

**NOTE: Failure to attend 80% of point-counting events does NOT mean that a driver retains their Rookie Eligibility in subsequent seasons.**

**29. ACT TESTING POLICY**

- ACT race teams will not be allowed to test at a racetrack 7 days prior to a scheduled or re-scheduled sanctioned event taking place.
- Teams will be allowed to test prior to opening of season (exception: 7 day rule at opening venue).
- After first race of season, teams may test up to a maximum of four sessions at any track at any time, except within 7 days of scheduled/re-scheduled event.
- Teams participating (attempting to qualify for event) in a weekly or special event are exempt from testing rule.
- Scheduled practice days associated with ACT-sanctioned event are waived from this policy.
- Amendments and special circumstances that alter this rule require the approval of the ACT Office.
- Violators of the testing policy may receive fines, point and/or other disciplinary or handicap penalties.

**IT IS THE RESPONSIBILITY OF THE COMPETITOR TO OBTAIN AND BECOME FAMILIAR WITH THE CURRENT RULES PERTAINING TO THE DIVISION IN WHICH HE/SHE CHOOSES TO PARTICIPATE.**

**ANY ITEM NOT COVERED IN THE ACT RULES SECTION MUST BE STOCK OR APPROVED IN WRITING BY ACT OFFICE. IF ANY ITEM BEING CONSIDERED BY COMPETITOR IN THIS DIVISION IS NOT ADDRESSED IN THESE RULES, COMPETITOR IS REQUIRED TO CONTACT ACT FOR A JUDGEMENT AS TO ACCEPTABILITY.**

The rules and/or regulations set forth herein are designed to provide for the orderly conduct of racing events and to establish minimum acceptable requirements for such events. These rules shall govern the condition of all events, and by participating in these events all participants are deemed to have obtained, read, and understood a copy of the current rules, and complied with these rules. **NO EXPRESS OR IMPLIED WARRANTY OF SAFETY SHALL RESULT FROM PUBLICATION OF OR COMPLIANCE WITH THESE RULES AND/OR REGULATIONS.** They are intended as a guide for the conduct of the sport and are in no way a guarantee against injury or death to a participant, spectator, or official.

All rules are subject to change in the interest of competition.

**Rules EIRI 112217-2**

**For Information Contact:**



**Website: [www.acttour.com](http://www.acttour.com)**

**Administrative Office**

**Telephone: 802-244-6963**  
**FAX: 802-244-1616**  
**E-Mail: [tb@acttour.com](mailto:tb@acttour.com)**

**For Technical questions:**

**Dean Gallison between the hours of 6pm – 9pm**

**Telephone: (802)-229-6276**  
**Email: [dgallisondoc@aol](mailto:dgallisondoc@aol.com)**

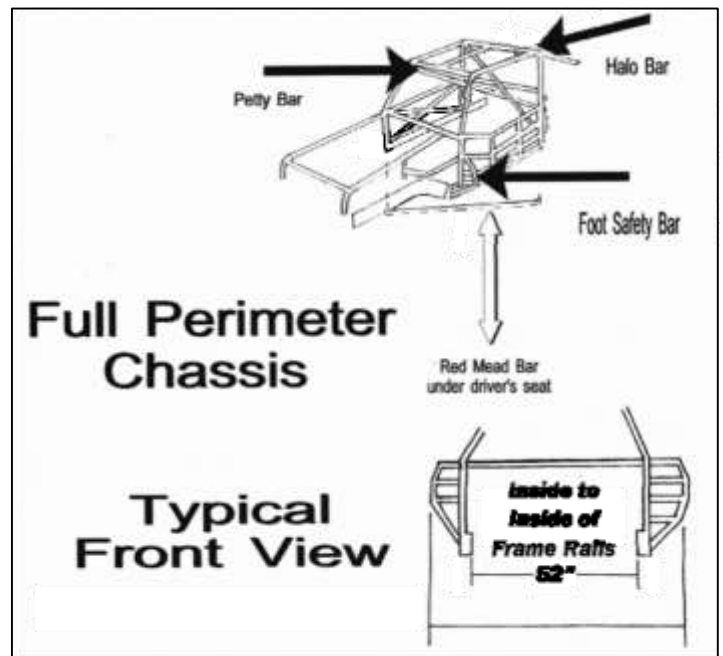
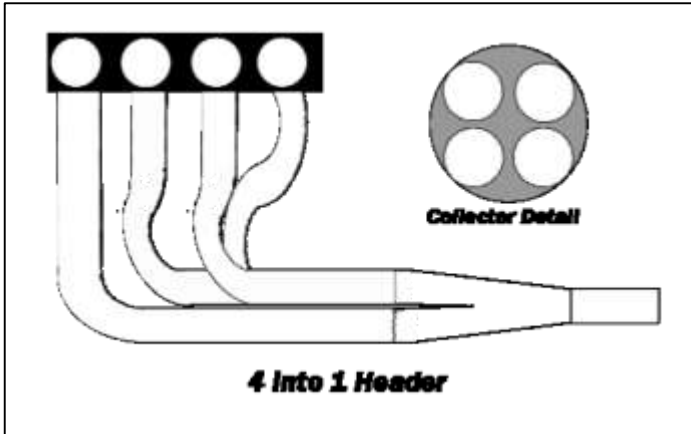

**ALL ACT FORD COMPETITORS WILL BE REQUIRED TO BOLT 20 lbs. OF LEAD DIRECTLY BEHIND UPPER CONTROL ARM SECTION OF FRAME RAIL – 10 lb. EACH RIGHT SIDE AND LEFT SIDE – SO AS TO BE CLEARLY VISIBLE, PER DIAGRAM BELOW. LEAD MUST BE PAINTED WHITE AND READILY AVAILABLE TO BE MOVED FOR WEIGHING PURPOSES. THIS LEAD MAY NOT BE MOVED FROM THE ASSIGNED LOCATION AS FAR FORWARD TOWARD FRONT OF FRAME RAIL AS POSSIBLE.**

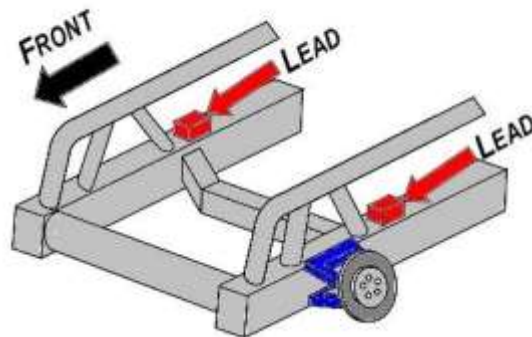

# Diagram A-2 Interior Detail

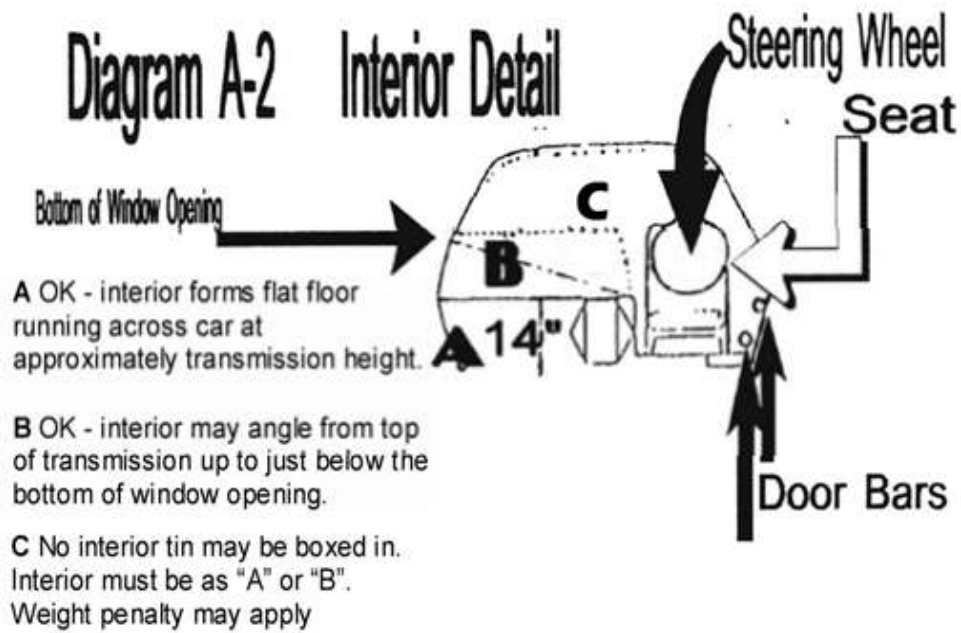



# CHASSIS NOTCHING

Teams MUST comply with 2 x 3 perimeter tubing rule. ACT approved fix for known issues are as follows:

Colored pieces indicate the position of approved known repairs to comply with ACT rules.

## Example: SNOOT 1 REPAIR – View from side of snout

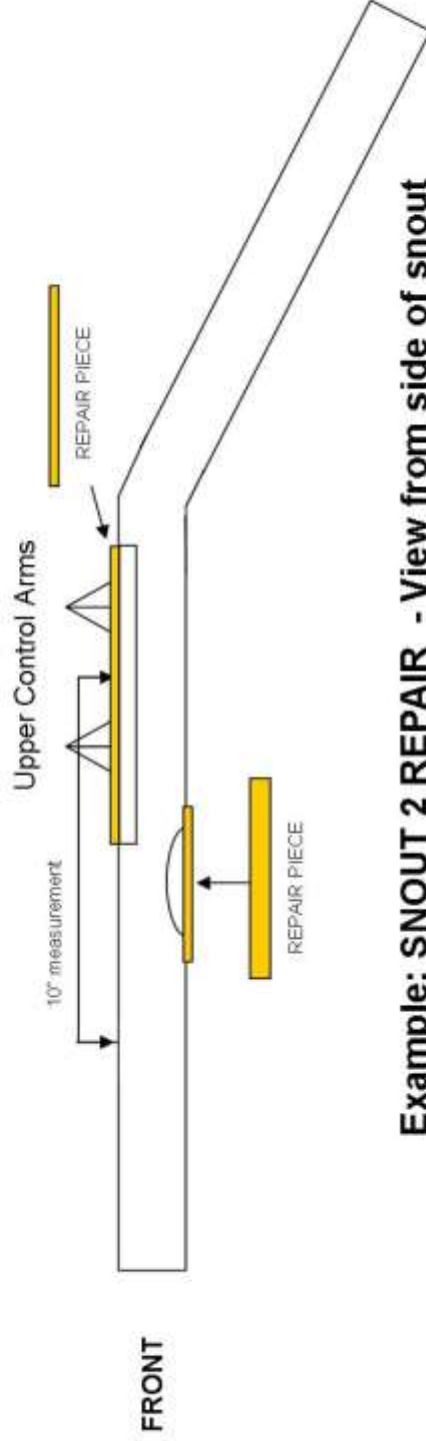

## Example: SNOOT 2 REPAIR - View from side of snout

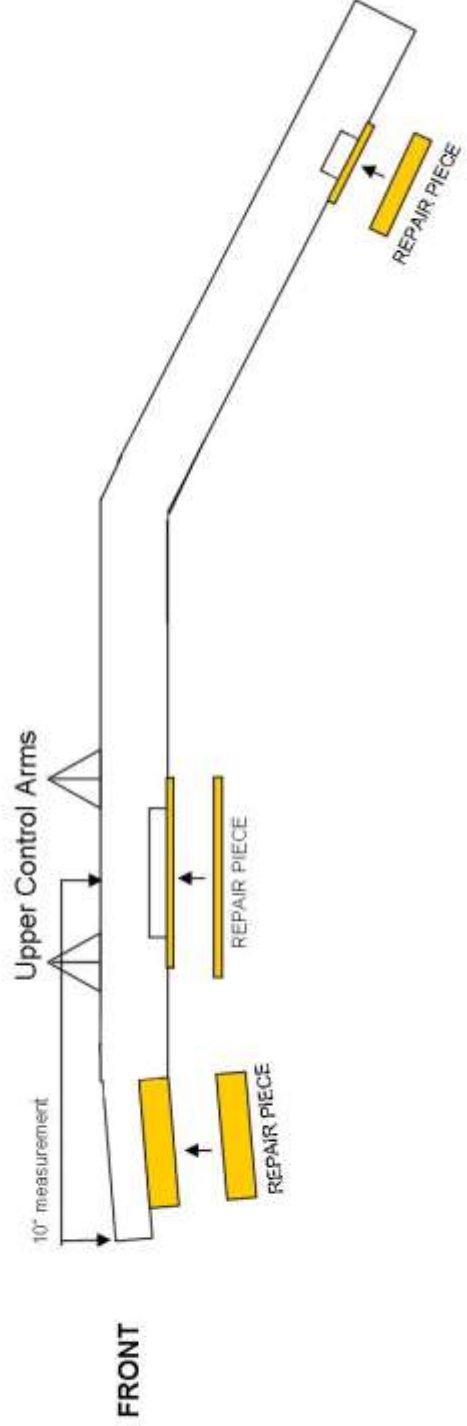



# ABC Body Dimension Sheet

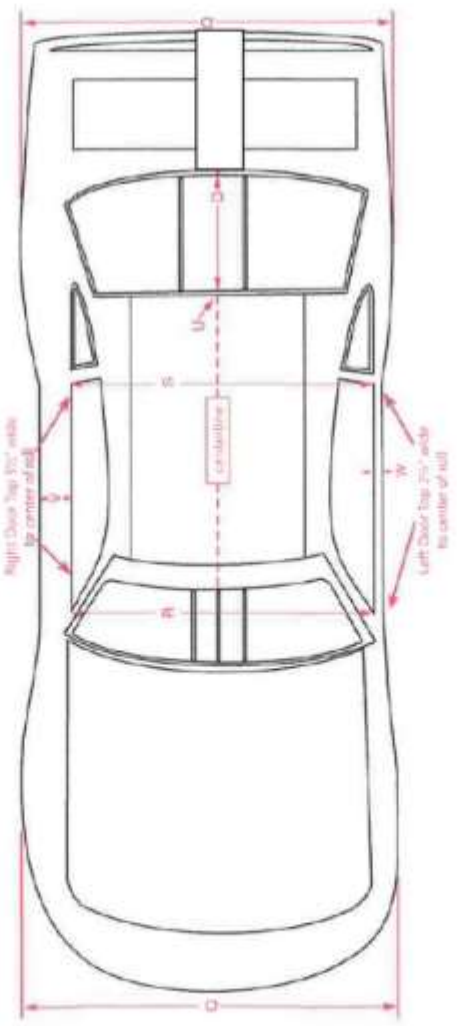
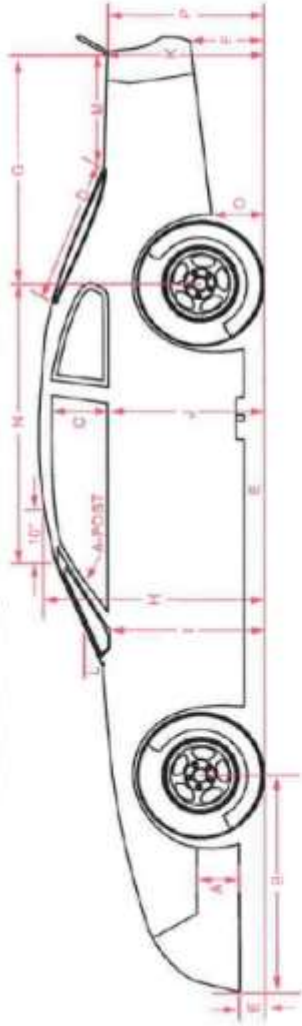

## Bumper Cover Location

See photo BC-1 on page 16 for full text.

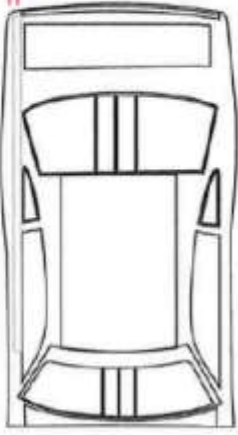

## Official ABC-approved Label Locations

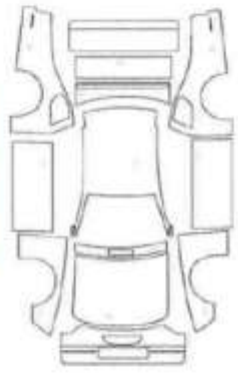

## ABC BODY DIMENSIONS

- A NOSE FLAP HEIGHT: 13"  
from bottom of nose to top of side flap\*\*\*
- B FRONT OVERHANG (MAX): 46"  
on centerline
- C SIDE WINDOW OPENING (MIN): 15"  
at B-post
- D REAR WINDOW LENGTH: on centerline\*\* 31 1/2"  
Five Star bodies  
AR bodies 31 1/8"
- E NOSE/SIDE PANEL CLEARANCE (MIN): 4"  
from ground
- F BUMPER COVER HEIGHT (MAX): 15"  
from ground
- G REAR OVERHANG (MAX): 47"  
from base of spoiler at centerline to axle centerline
- H ROOF HEIGHT (MIN): 47\*\*  
10" back from windshield, on centerline
- I FENDER HEIGHT: 32 1/2\*\*  
at rear
- J DOOR HEIGHT (MIN): 33\*\*  
at rear
- K QUARTER PANEL HEIGHT: 34 1/2\*\*  
at bumper cover/deck lid intersection (1/4-1/2")
- L WINDSHIELD ANGLE: 26/30°  
at center/rear roof windshield post
- M REAR DECK LENGTH (MAX): 23 1/4"  
at center, from base of spoiler to rear window\*\*  
Five Star bodies  
AR bodies 23 3/8"
- N FRONT OF ROOF TO CENTER OF REAR AXLE: 57 1/2"  
at back of wheel well opening
- O QUARTER PANEL HEIGHT: 13"  
at back of wheel well opening
- P BUMPER COVER HEIGHT: 34 7/8\*\*  
at base of spoiler, on centerline
- Q BODY WIDTH (MAX): 79 1/2"  
at wheel wells
- R DOOR TO DOOR WIDTH (measured through cart): 68"  
at A-posts and inside edges of doors
- S DOOR TO DOOR WIDTH (measured through cart): 67"  
at B-posts and inside edges of doors
- U ROOF HEIGHT, REAR: 45 1/2"  
at centerline
- V RIGHT DOOR TOP: 3 1/2"  
to center of roll
- W LEFT DOOR TOP: 2 1/2"  
to center of roll

\* If Dimensions H, I, J, K or P are higher than the stated dimensions, all five must increase by the same amount.  
 \*\* Must fit centerline asymptote within allowable tolerance.  
 \*\*\* 12 inches is the height of the nose flap only. This dimension is not measured from the ground.

ACT uses the Raceceiver transponder system. If you currently use a Raceceiver transponder you will be allowed to use yours in our event. If you do not you will be issued a rental transponder on the day of the event.



### **Late Model Transponder Mounting Locations**

The transponder must be mounted in compliance with the diagrams provided below. It must be mounted on a bracket inside frame rails. The center of the transponder must be **six (6) inches** back from the rear edge of the rear end tube (see diagram #1). Also the bottom most part of the transponder should not be below the bottom most part of frame. Transponder must be mounted in a direct horizontal plane (see diagram #2) to the ground with label side down and lights point towards the front or rear of the car. The clearance from the racetrack to the bottom of the transponder should be as close to a maximum of twelve (12) inches as possible.

**DIAGRAM #1**

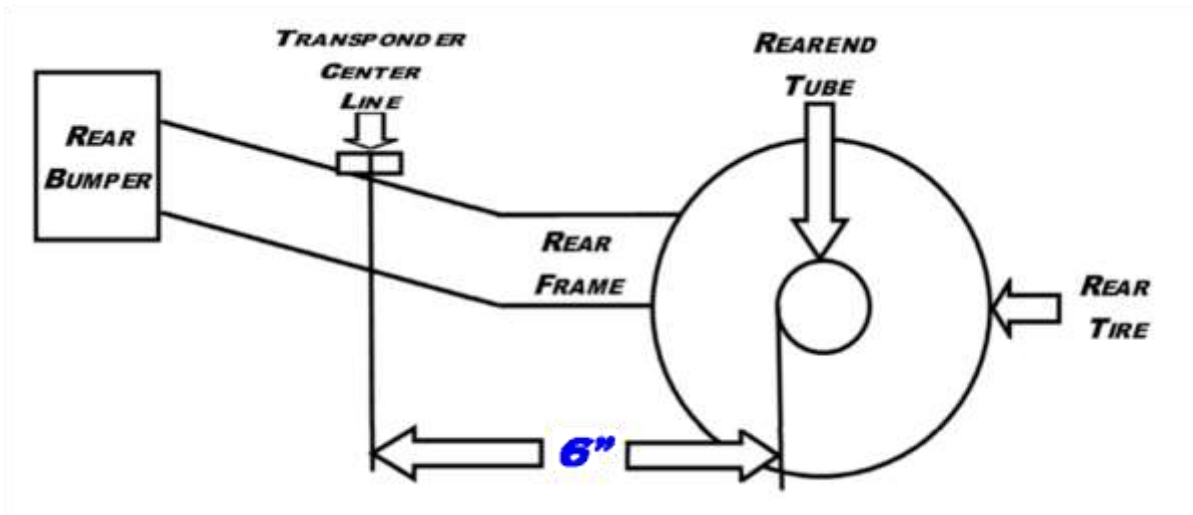

**DIAGRAM #2**

### ***VIEW OF TRANSPONDER AS SEEN FROM TRACK SURFACE***

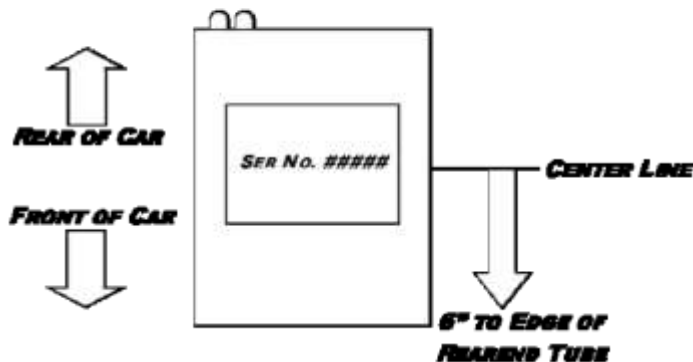

**NOTE:** Permanent Hardwired Transponders are available for purchase and are mounted in the same orientation and position as the rentals. Rental transponders must be returned after each event. To purchase a transponder contact Raceceiver – [www.raceceiver.com](http://www.raceceiver.com) or 866-301-7223. Any mounting questions should be directed as with any other rules question to Dean Gallison at 802.229.6276 between 6pm and 9pm on weekdays.

Crate Engine Owner \_\_\_\_\_

Team # \_\_\_\_\_

Driver \_\_\_\_\_

Division \_\_\_\_\_

**ACT 2018 ACT LATE MODEL CRATE MOTOR REGISTRATION ACT**

**ALL COMPETITORS USING A CRATE ENGINE TO COMPETE IN ANY ACT EVENT**

**MUST COMPLETE THE FOLLOWING AGREEMENT:**



**Engine Serial Number – (stamped on block, passenger side in front of head)**

**Crate Engine #1** \_\_\_\_\_ **Seal #** \_\_\_\_\_ **Seal #** \_\_\_\_\_ **Seal #** \_\_\_\_\_

**Crate Engine #2** \_\_\_\_\_ **Seal #** \_\_\_\_\_ **Seal #** \_\_\_\_\_ **Seal#** \_\_\_\_\_

**Engine Builder** \_\_\_\_\_

By registering and signing this agreement, you will be allowed to compete and receive prize money and points at ACT-sanctioned events. There will be NO prize money or points issued without registering spec engine with the ACT Office prior to competing.

**AGREEMENT:**

1. I agree to the policies regarding the ACT Late Model Crate engine program, as outlined in the ACT rules and regulations, procedural manual, this registration, or any other requirements which might be established.
2. I understand that the ACT Crate Engines are not to be tampered with. Any unauthorized breaking of the seals or unauthorized freshening or altering in any way is a violation of the ACT rules.
3. I understand that by registering my crate engine(s) and using it/them to compete in any ACT-sanctioned event, I, or my assigned driver(s), are subject to any and all penalties which might be imposed from time to time by the ACT organization.
4. I agree to abide by the ACT policy that a crate motor may be confiscated for inspection at any time. If the integrity of the said motor is not fully in compliance with the ACT rules and regulations, I further understand that I am subject to penalties which may be imposed by ACT, and my privilege to compete may be forfeited
5. Failure to comply with the demand of the ACT Official in Charge to confiscate crate motor for inspection purposes will result in suspension of all privileges for competitor(s) of sealed motor(s) to compete at any ACT events for up to one year. Other penalties may be issued. Team will be responsible to place motor in truck or trailer of ACT choice for transport to builder inspection facility. Cost of inspection and delivery will be borne by ACT if found legal, and all costs will be the responsibility of competitor if found illegal.

I understand and agree to the terms and conditions as outlined above.

\_\_\_\_\_  
**Crate Engine Owner**

\_\_\_\_\_  
**Crate Engine Driver**

\_\_\_\_\_  
**Witness**

\_\_\_\_\_  
**Witness**

\_\_\_\_\_  
**Date**

\_\_\_\_\_  
**Date**

# 2018 **Team Registration**

**PLEASE PRINT YOUR INFORMATION CLEARLY.** The information you provide is distributed to the media and used by ACT & Thunder Road internally. Info can be updated in the future if details change. Please mail or fax completed form at your earliest convenience.

***Please note: Car numbers are issued by the ACT office. If you do not have confirmation of your number, please leave this space blank. Thank you!***

DRIVER'S NAME: \_\_\_\_\_ DIVISION: \_\_\_\_\_

MAILING ADDRESS: \_\_\_\_\_

CITY: \_\_\_\_\_ STATE \_\_\_\_\_ ZIP CODE \_\_\_\_\_

PHONE (DAYS): \_\_\_\_\_ (EVENINGS): \_\_\_\_\_

CELL PHONE: \_\_\_\_\_ **E-MAIL:** \_\_\_\_\_

HOMETOWN: \_\_\_\_\_ STATE: \_\_\_\_\_ CAR #: \_\_\_\_\_ (\*)

CAR YEAR: \_\_\_\_\_ MAKE: \_\_\_\_\_ MODEL: \_\_\_\_\_

PRIMARY SPONSOR: (LIST ONE): \_\_\_\_\_

IF SPACE ALLOWS, DO YOU WANT ANOTHER SPONSOR LISTED? IF SO, WHAT NAME?:

CAR OWNER: \_\_\_\_\_ CREW CHIEF: \_\_\_\_\_

TEAM MEMBERS: \_\_\_\_\_

TRACK(S)/SERIES YOU'LL RUN: \_\_\_\_\_

**ALL LATE MODELS MUST COMPLETE RADIO FREQUENCY REQUEST (NO EXCEPTIONS)**

**LATE MODEL RADIO FREQUENCIES USED:**

1. \_\_\_\_\_ 2. \_\_\_\_\_ 3. \_\_\_\_\_ 4. \_\_\_\_\_

**SPOTTER:** \_\_\_\_\_

**RETURN TO: ACT REGISTRATION FORM, P.O. BOX 296, WATERBURY, VT 05676**

**FAX: 802-244-1616 Email: [tb@acttour.com](mailto:tb@acttour.com)**